

POWERSWITCH

Semiconductor Relay / - Contactor For Resistive Load PK 9260



Your Advantages

- High switching frequency and long life
- Space saving, only 22.5 mm width
- To be mounted on cooling surface with only 2 screws
- With heat sink for DIN-rail mounting
- Silent
- Vibration- and shock resistance

Features

- AC semiconductor relay / -contactor
- PK 9260/___ according to IEC/EN 62314
- PK 9260/___/___ according to IEC/EN 60947-4-2 and -4-3
- Load current up to 88 A, AC-51
- Switching at zero crossing for resistive loads
- 2 anti-parallel thyristors
- DCB technology (direct bonding method) for excellent heat transmission properties
- As option with:
 - M4 flat terminal or
 - M5 screw terminal for cable lug
- LED status indicator
- Peak reverse voltage up to ± 1600 V
- Insulation voltage 4000 V
- As option with heat sink, for DIN rail mounting

Function Diagram

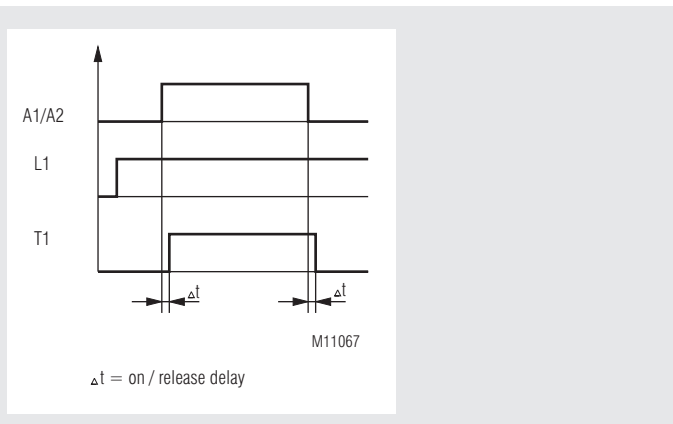

Approvals and Markings



Applications

Solid state relays switching at zero crossing:

For frequent no-wear and no-noise switching of:

- heating systems
- cooling systems
- valves
- lighting systems

The semiconductor relay switches at zero crossing and is suitable for many applications e.g. extrusion machines for plastic and rubber, packaging machines, solder lines, machines in food industry.

Circuit Diagram

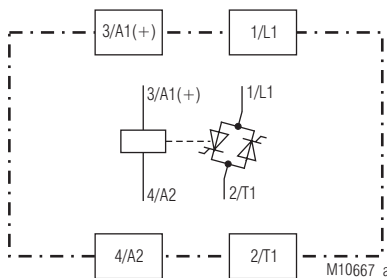

Notes

Depending on the application it may be useful to protect the semiconductor relay with special superfast semiconductor fuses against shortcircuit.

Without heat sink

The semiconductor relay can be mounted on existing cooling surfaces. Depending on the load, sufficient ventilation has to be provided.

With heat sink

For optimised heat dissipation the semiconductor relays can be delivered with special dimensioned heat sinks. Depending on the ambient conditions and the load this helps to select the correct semiconductor relay and heat sink. The heat sinks can be clipped on DIN-rail.

Notes

EMC disturbance during operation has to be reduced by corresponding measures and filters. If several semiconductor relays are mounted together sufficient cooling and ventilation has to be provided.

Control Circuit

Control voltage range [V]:	DC 4 ... 32	AC/DC 18 ... 30	AC 100 ... 230
Making voltage [V]:	3.0	10	80
Switch off voltage [V]:	1.0	6.0	25
Max. input current [mA]:	12	25 at 24 V AC	20 at 230 V AC
Start up delay [ms]:	≤ 1.0 + ½ cycle*	≤ 5 + ½ cycle*	≤ 10 + ½ cycle*
Release delay [ms]:	≤ 1.0 + ½ cycle*	≤ 20 + ½ cycle*	≤ 35 + ½ cycle*

*½ cycle delay only when switching at 0-crossing, at instantaneous switching the delay = 0

Output

Load voltage AC [V]:	24 ... 230	48 ... 460	48 ... 600
Peak reverse voltage [V]:	650	1200	1600
Frequency range [Hz]:	47 ... 63		

Semiconductor relays. heat sink see table Load current I _{henn} [A] / AC-51:	24	32	48	48*	72	88	
Semiconductor contactor at T _U = 40 °C: Designation heat sink: Load current I _{henn} [A] / AC-51: Current reduction above T _U = > 40 °C [A / °C]	/03 10 0.3	/04 20 0.4					
Max. overload current [A]. t = 10 ms:	≤ 350	≤ 400	≤ 400	≤ 620	≤ 1300*	≤ 1050	≤ 1150
Load limit integral I ² t [A ² s]:	612	800	800	1920	8500*	5500	6600
Leakage current in off state [mA]	≤ 1.5						
Min. current [mA]	20						
Forward-voltage [V] at at nominal current:	1.1	1.2	1.2	1.2	1.1	1.2	1.2
Off-state voltage [V/μs]:	500	500	1000	1000	1000	1000	1000
Rate of rise of current [A/μs]:	150	150	100	150	150	150	150

*½ at variant /1__ : High I²t

Thermal Data - Semiconductor Relays -

Thermal resistance junction-ambient [K/W]:	10					
Thermal resistance junction housing [K/W]:	0.55	0.48	0.36	0.25	0.35	0.25
Junction temperature [°C]:	≤ 125					

Notes on Sizing for Selection of a Heat Sink

The heat generated by the load current must be dissipated by a suitable heat sink. It is imperative that the junction temperature of the semiconductor is maintained for all potential environmental temperatures of under 125°C. For this reason, it is important to keep the thermal resistance between the base plate of the semiconductor relay and the heat sink to a minimum.

To protect the semiconductor relay effectively from excess heating, a thermally conducting paste or a graphit gasket (see Accessories) should be applied before installation to the base plate of the heat sink between semiconductor relay and heat sink.

From the table, select a suitable heat sink with the next lowest thermal resistance. Thus, it is ensured that the maximum junction temperature of 125°C is not exceeded. The load current in relation to the environmental temperature can be seen from the table.

a)							
	Load current (A)	PK 9260 24 A Thermal resistance (K/W)					
	24.0	3.6	3.2	2.8	2.4	2.0	1.6
	21.6	4.1	3.7	3.2	2.8	2.3	1.9
	19.2	4.8	4.3	3.8	3.3	2.8	2.2
	16.8	5.5	5.0	4.5	3.9	3.3	2.7
	14.4	7.0	6.3	5.5	4.8	4.1	3.4
	12.0	8.5	7.8	6.9	6.0	5.2	4.3
	9.6	-	-	9.0	7.9	6.8	5.6
	7.2	-	-	-	-	9.5	7.9
	4.8	-	-	-	-	-	-
	2.4	-	-	-	-	-	-
		20	30	40	50	60	70
		Ambient temperature (°C)					

Selection of a Heat Sink

b)

Load current (A)	PK 9260 32 A Thermal resistance (K/W)					
	20	30	40	50	60	70
32.0	2.0	1.9	1.6	1.3	1.1	0.8
28.8	2.5	2.2	1.9	1.6	1.3	1.0
25.6	3.0	2.7	2.3	2.0	1.6	1.3
22.4	3.7	3.3	2.8	2.4	2.0	1.6
19.2	4.5	4.0	3.5	3.1	2.6	2.1
16.0	5.8	5.2	4.5	3.9	3.3	2.7
12.8	7.6	6.8	6.1	5.3	4.5	3.7
9.6	-	9.7	8.6	7.5	6.4	5.3
6.4	-	-	-	-	-	8.5
3.2	-	-	-	-	-	-

c)

Load current (A)	PK 9260 48 A / 48 A Hi Pt Thermal resistance (K/W)					
	20	30	40	50	60	70
48.0	1.3	1.2	1.0	0.8	0.6	0.5
43.2	1.6	1.4	1.2	1.0	0.8	0.6
38.4	1.9	1.7	1.5	1.2	1.0	0.8
33.6	2.4	2.1	1.8	1.6	1.3	1.0
28.8	3.0	2.6	2.3	2.0	1.6	1.33
24.0	3.8	3.4	3.0	2.6	2.2	1.8
19.2	5.1	4.6	4.0	3.5	3.0	2.4
14.4	7.2	6.5	5.8	5.0	4.3	3.6
9.6	-	-	9.3	8.1	7.0	5.8
4.8	-	-	-	-	-	-

d)

Load current (A)	PH 9260 72 A Thermal resistance (K/W)					
	20	30	40	50	60	70
72.0	0.7	0.6	0.5	0.4	0.3	-
64.8	0.9	0.8	0.7	0.5	0.4	0.3
57.6	1.1	1.0	0.8	0.7	0.5	0.4
50.4	1.5	1.3	1.1	0.9	0.7	0.5
43.2	1.9	1.6	1.4	1.2	1.0	0.7
36.0	2.4	2.2	1.9	1.6	1.3	1.1
28.8	3.3	3.0	2.6	2.2	1.9	1.5
21.6	4.8	4.3	3.8	3.3	2.8	2.3
14.4	7.8	7.0	6.2	5.5	4.7	3.9
7.2	-	-	-	-	-	8.6

e)

Load current (A)	PK 9260 88 A Thermal resistance (K/W)					
	20	30	40	50	60	70
88.0	0.6	0.5	0.4	0.3	-	-
79.2	0.7	0.6	0.5	0.4	0.3	-
70.4	0.9	0.8	0.7	0.6	0.4	0.3
61.6	1.2	1.0	0.9	0.7	0.6	0.4
52.8	1.5	1.3	1.1	1.0	0.8	0.6
44.0	2.0	1.8	1.5	1.3	1.1	0.9
35.2	2.7	2.4	2.1	1.8	1.5	1.2
26.4	3.9	3.5	3.1	2.7	2.3	1.9
17.6	6.3	5.7	5.0	4.4	3.8	3.1
8.8	-	-	-	9.7	8.3	7.0

Semiconductor Contactor

Semiconductors with optimised heat sink

We recommend the following combination of semiconductor relay and heatsink depending on the load current and an ambient temperature of 40° C.

If the semiconductor relays are used at ambient temperature above 40°C the load current has to be reduced according to the current reduction (A/°C see table).

Example:

Operation at $T_U = 45^\circ\text{C}$; heat sink for 10 A with $0.3 \text{ A} / ^\circ\text{C}$

Current reduction: $5^\circ\text{C} \times 0.3 \text{ A} / ^\circ\text{C} = 1.5 \text{ A}$

Max. load current: $10 \text{ A} - 1.5 \text{ A} = 8.5 \text{ A}$

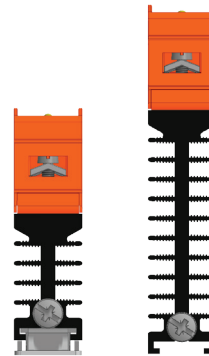

/03
10 A

/04
20 A

General Technical Data

Operating mode:	Continuous operation (Current reduction above 40 °C)
Temperature range	
operation:	- 25 ... 60° C
storage:	- 25 ... 85° C
Relative air humidity:	< 95 % non-condensing at 40 °C
Clearance and creepage distances	
rated impulse voltage / pollution degree:	6 kV / 2 IEC/EN 60 664-1
EMC:	IEC/EN 61 000-6-4, IEC/EN 61 000-4-1
Electrostatic discharge (ESD):	8 kV air / 6 kV contact IEC/EN 61 000-4-2
HF irradiation:	10 V / m IEC/EN 61 000-4-3
Fast transients:	2 kV IEC/EN 61 000-4-4
Surge voltages	
Control circuit between A1 / A2:	1 kV IEC/EN 61 000-4-5
between output and ground:	2 kV IEC/EN 61 000-4-5
HF-wire guided	10 V IEC/EN 61 000-4-6
Interference suppression:	Limit value class A IEC/EN 60 947-4-3
Degree of protection:	IP 10 IEC/EN 60 529
Vibration resistance:	Amplitude 0.35 mm Frequency 10 ... 55 Hz, IEC/EN 60-068-2-6
Housing material:	PBT/PC flame resistant; UL 94 V0
Base plate:	Aluminum, copper nickel-plated
Mounting screws:	M4 x 20 mm
Mounting torque:	2.5 Nm
Connections load circuit / __ 0:	Mounting screws M4 Pozidrive 1 PT 2.5 Nm Wire cross section: 2 x 1.5 ... 2.5 mm ² solid or 2 x 2.5 ... 6 mm ² solid oder 2 x 1.0 ... 2.5 mm ² stranded wire with sleeve 2 x 2.5 ... 6 mm ² stranded wire with sleeve 1 x 10 mm ² stranded wire with sleeve
Connections load circuit / __ 1:	Mounting screws M5 2.5 Nm cable lug (DIN 46234): 5 - 2.5; 5 - 6; 5 - 10; 5 - 16; 5 - 25
Connections control circuit:	Mounting screws M3 Pozidrive 2 PT 0.6 Nm Wire cross section: 1 x 0.5 ... 2.5 mm ² solid or 2 x 0.5 ... 1.0 mm ² solid or 1 x 0.5 ... 2.5 mm ² stranded wire with sleeve
Nominal insulation voltage	
Control circuit – load circuit:	4 kV _{eff.}
Load circuit – base plate:	4 kV _{eff.}
Overvoltage category:	III
Weight	
without heat sink:	approx. 80 g
with heat sink	
Load current	
10 A:	approx. 178 g
20 A:	approx. 255 g

Dimensions

Width x height x depth

without heat sink

with screw terminals:	22.5 x 85 x 50 mm
with cable lug terminals:	22.5 x 139 x 50 mm

with heat sink

Load current	
10 A:	22.5 x 99 x 92 mm
20 A:	22.5 x 99 x 131 mm

Standard Type

PK 9260.91 AC 48 ... 460 V	24 A DC 4 ... 32 V
Article number:	0064884
• Load voltage:	AC 48 ... 460 V
• Load current:	24 A
• Control voltage:	DC 4 ... 32 V
• Width:	22.5 mm

Variants

PK 9260 .91 / _ _ _ / 0 _	
0	Without heat sink
3	With heat sink 10 A
4	With heat sink 20 A
5	With heat sink 40 A (on request)
6	With heat sink 60 A (on request)
0	M4 flat terminal
1	M5 screw terminal (cable lug)
0	Switching at zero crossing
0	Standard
1	With high I ² t-value

Ordering example for variants

PK 9260.91 / 1 0 0 / 04	AC 48 ... 460 V	20 A	DC 4 ... 32 V
			Control voltage
			Load current
			Load voltage
			with heat sink 20 A
			M4 flat terminal
			Switching at zero crossing
			With high I ² t-value
			Type

Connection Example

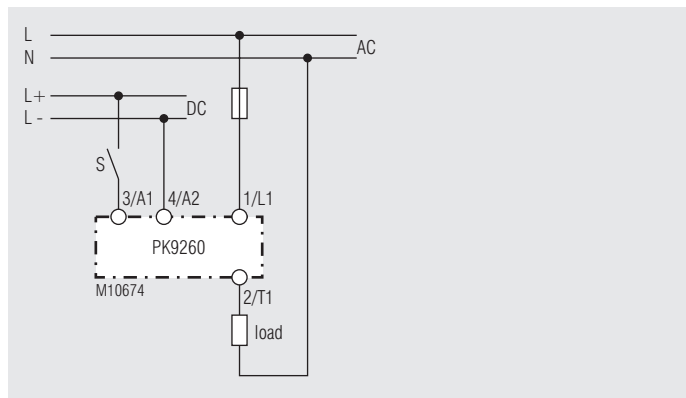

single-phase

Dimensions

Flat terminals
PK 9260.91/_ _0

Screw terminals / cable lug terminals
PK 9260.91/_ _1

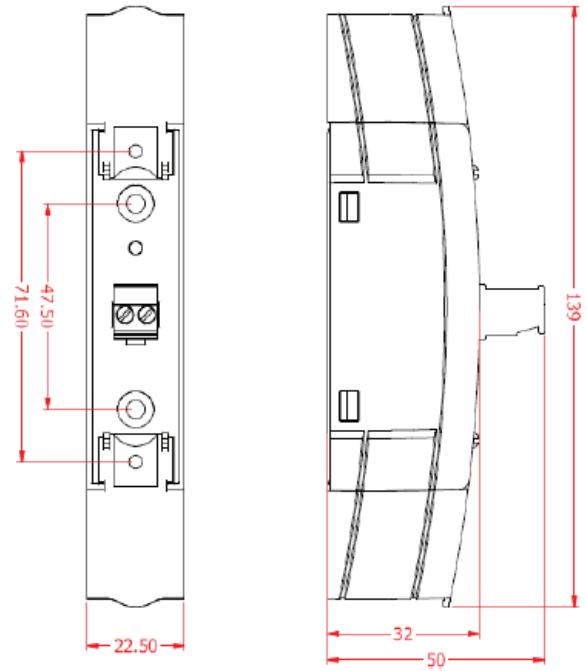
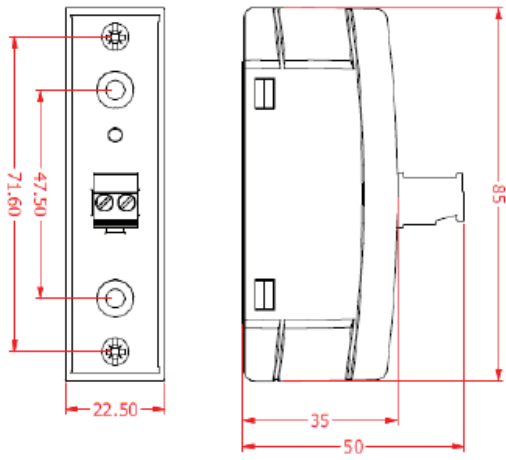

PK 9260.91/_ _0 /03

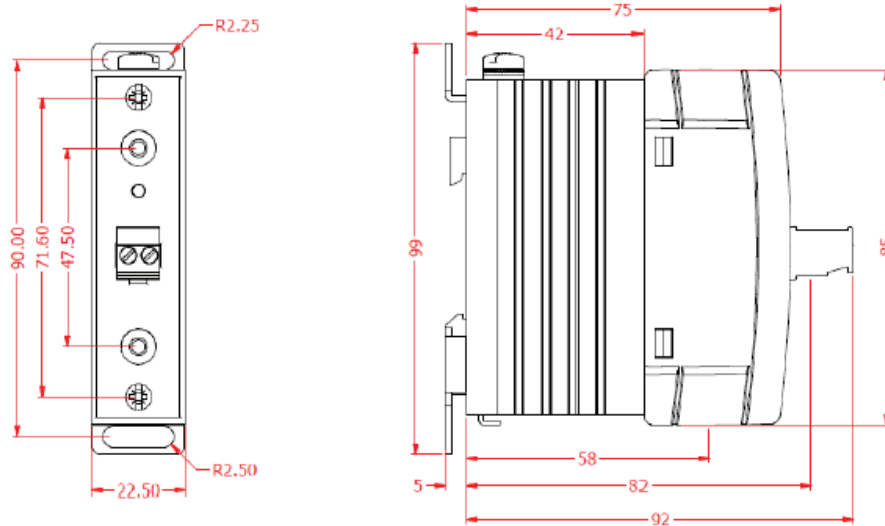

PK 9260.91/_ _0 /04

