

VARIMETER

Frequency Relay

MK 9837N/5_0, MH 9837/5_0

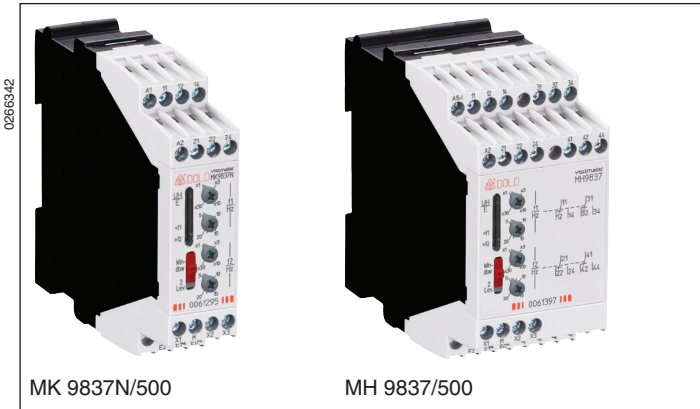

MK 9837N/500

MH 9837/500

Setting

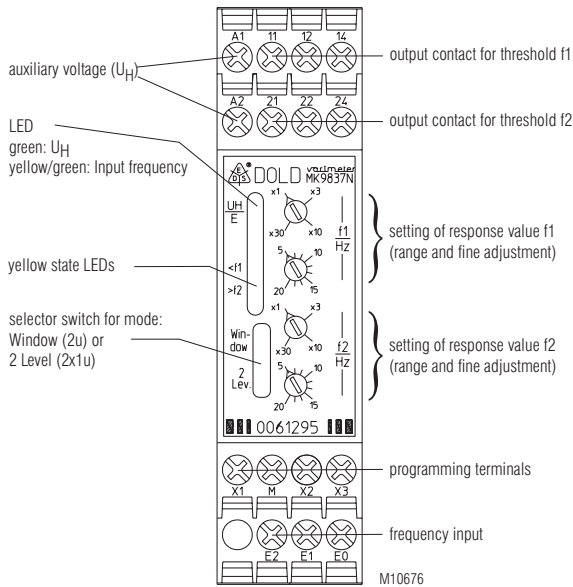

Your Advantages

- Separate output signals for under and over frequency
- Simple wiring
- Easy handling

Features

- According to IEC / EN 60 255, VDE 0435 Teil 303
- Monitoring of AC voltage for under and overfrequency, can be used also for pre-warning
- Separate relay outputs for over- or underfrequency (1 or 2 changeover contacts each)
- Alternative usage for monitoring of a frequency window
- Separate adjustment of response value for over- or underfrequency at 4 ranges each, 1.5 ... 200 Hz or 5 ... 600 Hz
- Second response value for prewarning possible
- Fast reaction time by measuring duration of cycle of input frequency
- Universal measuring input for AC-voltages of 15 ... 280 V as well as 30 ... 550 V
- As option with measuring input for inverters
- Programmable hysteresis of response value: 2 ... 10 %
- Start up time delay programmable via terminals from 0 ... 50 s e.g. continuously
- Manual or auto-reset programmable via terminals
- Galvanic separation between measuring input, auxiliary voltage and output contacts
- MH 9837/508: with galvanic separated analogue output (current/voltage) and 11 step LED chain for the actual frequency
- MH 9837/5_0: with wide input range for auxiliary voltage available (AC/DC 24 ... 60 V or AC/DC 110 ... 230 V)
- Closed circuit operation (de-energized on trip)
- LED indication for auxiliary voltage, measuring voltage and alarm status
- Device available with 2 contacts
MK 9837N/5_0: 2 x 1 changeover contact
MH 9837/5_0: 2 x 2 changeover contacts or wide auxiliary voltage range
- 2 possible compact designs:
MK 9837N/5_0: Width 22,5 mm
MH 9837/5_0: Width 45 mm

Approval and Marking



*) only MK 9837N/5_0

Application

- Monitoring of frequency in AC systems
- Monitoring of rotor frequency on slip ring motors
- Control and monitoring of motors in sewage water treatment plants
- Monitoring of output frequency on inverters (variant /550)

Function Diagram

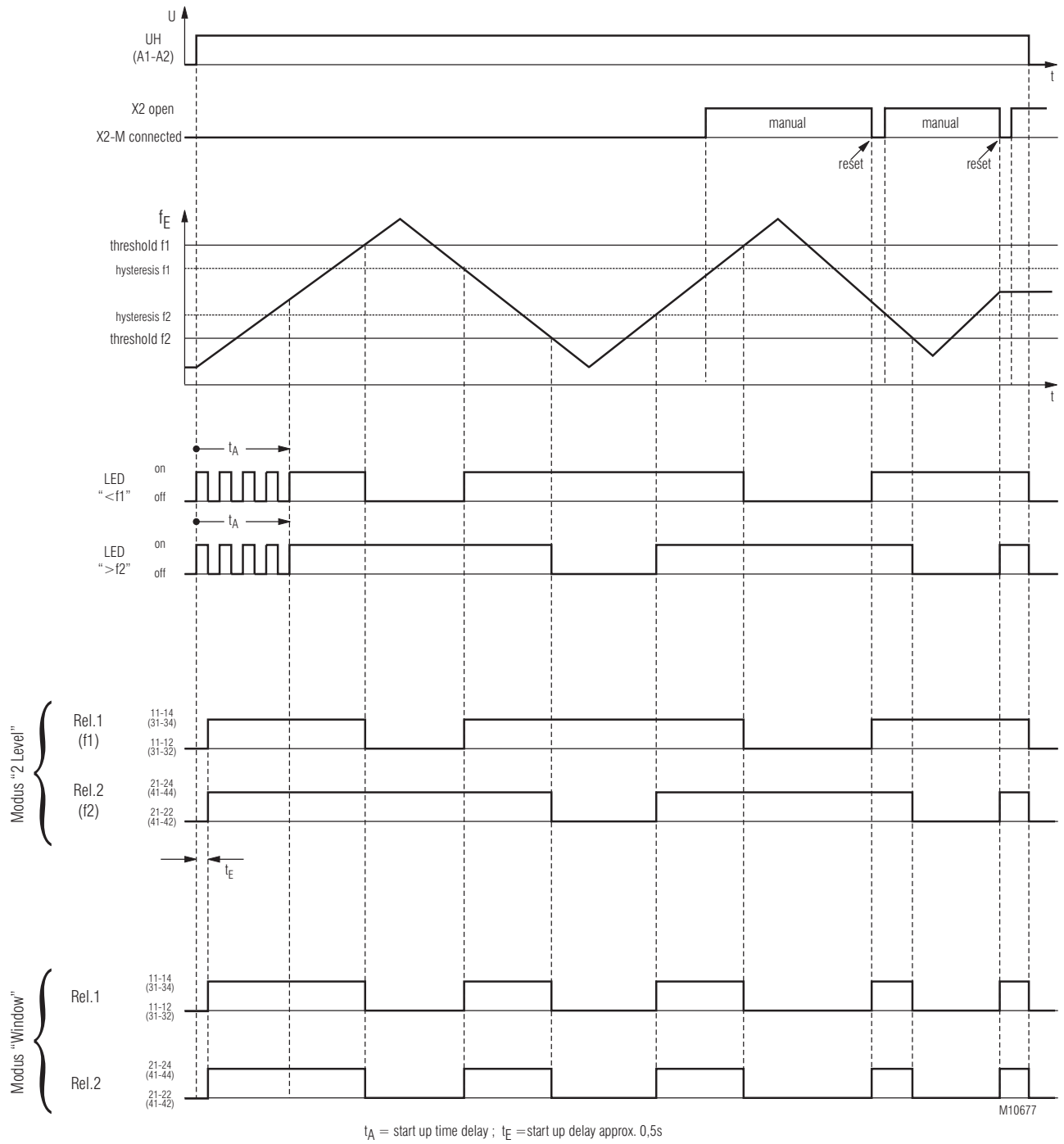

Circuit Diagrams

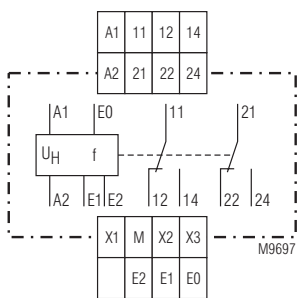

MK 9837N/500

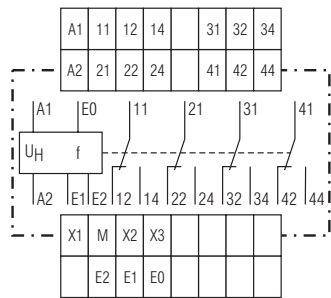

MH 9837/500

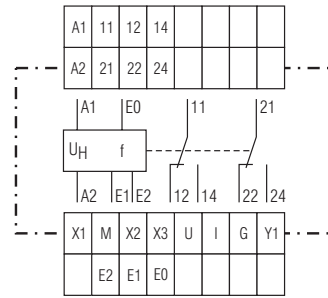

MH 9837/508

Connection Terminals

Terminal designation	Signal designation
A1+, A1	+ / L
A2	- / N
E0, E1, E2	Frequency input
X1, X2, X3	Programming terminals
M	Reference for programming terminals
U	Analogue output voltage
I	Analogue output current
G	Reference for analogue output
Y1	Range selection for analogue output
11, 12, 14, 21, 22, 24, 31, 32, 34, 41, 42, 44	"monitoring output frequency failure (2 or 4 changeover contacts)"

Functions

The auxiliary supply is connected to terminals A1-A2.

Terminals E0-E1-E2 form the measuring input. For low voltages the measuring voltage is connected to E1-E0 and for higher voltages to E2-E0 (see section technical data).

The input frequency is compared to the setting value for over- and underfrequency (response value f1 e.g. f2 = fine tuning x range).

As the device measures the cycle duration the fastest frequency measurement is possible (reaction time = cycle time + 10 ms).

If the input frequency on the measuring input E0-E1-E2 is under the response value f1 less hysteresis (both upper potentiometers) and over the response value f2 (both lower potentiometers) plus hysteresis then the output relays are energized and the yellow LEDs "<f1" and ">f2" are on.

If the frequency rises above the value of f1, the relay 1 de-energizes (contacts 11-12 close) in "2 level mode", in "window mode" also relay 2 de-energizes (contacts 21-22 close). The yellow LED "<f1" goes off. Only when the input frequency drops under the level f1 minus hysteresis, the output relay (both relays in window mode) energize again and the yellow LED "<f1" is on.

If the frequency drops below the value of f2, the relay 2 de-energizes (contacts 21-22 close) in "2 level mode", in "window mode" also relay 1 de-energizes (contacts 11-12 close). The yellow LED "<f2" goes off. Only when the input frequency rises above the level f2 plus hysteresis, the output relay (both relays in window mode) energize again and the yellow LED "<f2" is on.

If manual reset is active (terminal x2 not connected) and the frequency returns to good state the relay (relays) remain in alarm position (de-energized) and the corresponding LED is off. To reset the alarm terminals X2-M must be bridged, or the auxiliary supply has to be switched off and on again.

If a start-up delay is adjusted, this delay starts with the connection of the auxiliary supply. During this time the frequency is not detection is off, the yellow LEDs "<f1" and ">f2" flash and the output relays are in good state (energized). The start-up delay allows to avoid alarms during the starting period of a generator or motor.

Using the sliding switch on the front of the unit the user can chose between the two function modes "2-level mode" and "window mode".

„2 level-mode“: 2x1 c/o contacts; the output relays 1 and 2 switch separately at the corresponding response value f1 and f2.

„window-mode“: 2 c/o contacts; the output relays switch together at the response values for f1 and f2 (where f1>f2); i.e. the relays switch off together the frequency rises over f1 or drops under f2.

Indicators

Upper LED „UH/E“: - green, when only auxiliary voltage connected to A1 - A2
 - yellow/green, when measuring frequency is detected on E0-E1-E2

Lower LED „<f1“ (yellow): - On, input frequency is lower than response value f1 (= relay 1 energized in "2-level mode")

Lower LED „>f2“ (yellow): - On, when input frequency is higher than response level f2 (= relay 2 energized in "2-level mode")
 LEDs "<f1" and ">f2" flashes during start up delay

Notes

Setting of response values f1 and f2 / function energized on trip for output relays

Normally the response value f1 is used for overfrequency and f2 for underfrequency the hysteresis works accordingly to these settings. Both relays operate de-energized on trip. In "2-level-mode" the frequency detection and the control of the corresponding relays at the response values f1 and f2 work completely independent. So it is possible to adjust f2 higher than f1 if auto reset is selected. If f2 is used for overfrequency, the unit works energized on trip, as the relay 2 (21-22-24) always energizes when the frequency rises above response value + hysteresis. In the same way the response value f1 - hysteresis can be used for underfrequency so that relay 1 (11-12-14) is energized on trip.

When using manual reset in "window mode" the response value f1 (minus hysteresis) must always be higher than f2 (plus hysteresis) to avoid that the output relays do not switch anymore and the yellow LEDs "<f1" and ">f2" remain dark.

Frequency measuring input

The standard measuring input is divided up in to voltage ranges (E1-E0 AC 15... 280 V and E2-E0 AC 30 ... 550 V). If the measuring voltage is always higher then AC 30 V, the higher range should be used.

To measure the output frequency on inverters the variant /550 has to be used. A special dimensioned measuring input with low pass characteristic avoids the measuring of the pulse frequency. In addition the input sensitivity is adapted to the voltage-/frequency-characteristic of inverters (see diagram in technical data).

Visual indication of measuring voltage:

If the voltage on the frequency measuring input is high enough for monitoring the upper dual color LED "UH/E" is ON yellow/green. If the voltage on the input is to low, the LED "UH/E" shows only green color.

Attention! If the measuring voltage is to low the unit reacts as on underfrequency!

Programming terminals (M-X1-X2-X3):

Attention! The terminals M-X1-X2-X3 have no galvanic separation to the measuring circuit (E0-E1-E2), and must be operated potential free.

- M: Common connection (Ground) of the programming terminals
- X1: start up delay at range of 0...50 s is achieved by connecting a X1 to M with a potentiometer (0.25 W) or fixed resistor (see technical data). If no start up delay is required the terminals X1-M must be linked.
- X2: Manual reset with NO contact push button on X2-M, auto reset with terminals X2-M bridged.
- X3: Hysteresis setting at range of 2...10 % is achieved by connecting the terminal X3 to M with a potentiometer (0.25 W) or fixed resistor (see technical data).
 For a hysteresis of 2 % the terminal X3 remains open;
 for a hysteresis of 10 % s the terminals X3-M must be linked.

Start up delay

A start up delay ($t_A = 0 \dots 50$ s) adjusted by connecting a resistor $0 \dots 500$ kOhm to the terminals X1 and M see technical data. This start up delay is started when connecting the auxiliary supply. During this time monitoring is disabled and both output relays are energized. If the connection between X1 and M is open circuit (resistance > 500 kOhm), the startup delay is continuously on. With this possibility the frequency monitoring can be disabled by an external contact until e.g. a system reaches its normal operation status. When the circuit X1 – M closes the time delay set by a resistor in this circuit runs down before the monitoring starts.

If no start up delay is required, the terminals X1-M must be linked. There must be a connection between X1-M when the frequency should be monitored.

While the start up delay is active, the yellow LEDs "<f1" and ">f2" flash with 2 Hz. To adjust a specific time the number of flashing cycles can be counted. Number of cycles divided by 2 = start up time in seconds.

Notes

Manual / automatic reset

To enable manual reset the connection X2-M remains open. Storing of the alarm influences the output relays and the corresponding LEDs. Reset is made by closing the connection between X2 and M or by disconnecting the auxiliary supply.

Setting of hysteresis

Connecting terminal X3 via a resistor to M adjusts the hysteresis. Both response values (f1 and f2) have the same hysteresis in percentage of the adjusted response values. So the absolute value of the hysteresis is higher on the higher response value than on the lower response value.

Variant MH 9837.38/508: (45 mm width)

Identically to MK 9837N.12, but with 11 step LED chain indicator and galvanic separated analogue output to display the actual measured frequency. On terminals U/G of the analogue output 0-10 V are provided, on terminals I/G 0 ... 20 mA are available. By bridging terminals Y1 and G the output can be switched over to 2 ... 10 V and 4 ... 20 mA. The max. value of the analogue output is indicating 2 times of the max. value of the selected range this allows also to indicate overfrequency values. The scaling is linear to the input frequency (lowest analogue value is 0 Hz). The LED chain indicator shows on 10 LEDs the actual frequency ($\leq 10\% \dots 100\%$ of the setting range). If the frequency exceeds the maximum value of the range the indicator is switched over to 2 x max value and the top LED (red) is on.

Technical Data

Frequency Measuring Input (E0-E1-E2)

Standard-frequency measuring

Voltage range

E0-E1: AC 15 ... 280 V,
E0-E2: AC 30 ... 550 V

Input resistance

E0-E1: approx. 300 k Ω
E0-E2: approx. 850 k Ω

Frequency measuring input for inverters (variant /550)

Max. input voltage: AC 550 V
Min. measuring voltage: approx.. AC 10 V (at 1 Hz) ... AC 150 V (at 200 Hz); (see characteristic M8681)
Input resistance: approx. 900 k Ω

Common Data for Both Measuring Inputs

Galvanic separation: Frequency measuring input to auxiliary voltage and output contacts

Frequency ranges: (separately selectable for f1 and f2)

1.5 ... 6 Hz	5 ... 20 Hz	15 ... 60 Hz	50 ... 200 Hz or
5 ... 20 Hz	15 ... 60 Hz	50 ... 200 Hz	150 ... 600 Hz 4 ranges selectable each

Response time f1, f2

(response value): separately adjustable at absolute scale

Tolerances of the adjusted tripping values at variation of auxiliary supply and temperature:

Hysteresis: approx. $\pm 1\%$ adjustable from 2 ... 10 % with resistor/potentiometer across terminals X3-M

Resistance:	0	15 k Ω	39 k Ω	120 k Ω	∞
Hysteresis:	10 %	8 %	6 %	4 %	2 %

Reaction time of

Frequency monitoring: Duration of 1 cycle (inverse value of adjusted frequency) + 10 ms adjustable from 0 ... 50 s with resistor/potentiometer across terminals X1-M:

R / k Ω :	0	15	22	33	47	68	100	150	220	470	∞
t _v / s:	0	0,3	0,7	1,3	2,3	5	9	15	25	50	∞

Time between connection of auxiliary supply and ready to measure:

approx. 0.5 s (with start up delay is 0)

Technical Data

Auxiliary Circuit (A1-A2)

Auxiliary voltage U_H

(galvanic separation): AC 115, 230, 400 V
DC 12, 24, 48 V
AC/DC 24 ... 60, 110 ... 230 V (only for MH-version possible)

Voltage range

AC: 0.8 ... 1.1 U_H
DC: 0.9 ... 1.2 U_H
AC/DC: 0.75 ... 1.2 U_H

Frequency range

AC: 45 ... 440 Hz

Nominal consumption:

AC: approx. 4 VA
DC: approx. 2 W

Output (11-12-14, 21-22-24 + 31-32-34, 41-42-44 at MH 9837.39/5_0)

Contacts:

MK 9837N.38/5_0: 2 x 1 changeover contact (1 each for over- and underfrequency alarm)
MH 9837.39/5_0: 2 x 2 changeover contacts (2 each for over- and underfrequency alarm)
4 A

Thermal current I_{th}:

Switching capacity

to AC 15
NO contact: 3 A / AC 230 V IEC/EN 60 947-5-1
NC contact: 1 A / AC 230 V IEC/EN 60 947-5-1
to DC 13
NO contact: 1 A / DC 24 V IEC/EN 60 947-5-1
NC contact: 1 A / DC 24 V IEC/EN 60 947-5-1

Electrical life

to AC 15 at 1 A, AC 230 V: 1,5 x 10⁶ switching cycles IEC/EN 60 947-5-1

Short circuit strength

max. fuse rating: 4 A gL IEC/EN 60 947-5-1
Mechanical life: $\geq 30 \times 10^6$ switching cycles

Analogue Output with MH 9837.38/508

galvanic separation AC 3750V

to auxiliary supply, measuring circuit and relay outputs

terminal U(+) / G(-): 0 ... 10 V, max. 10 mA
terminal I (+) / G(-): 0 ... 20 mA, max. burden 500 Ohm
change to 2 ... 10 V or 4 ... 20 mA by bridging terminal Y1 and G. scaling is linear with frequency (lowest value at f = 0, highest value at 2 x max setting value)

General Data

Nominal operating mode: continuous operation

Temperature range: - 20 ... + 60°C

Clearance and creepage distance

rated impuls voltage / pollution degree:
output to measuring circuit: 4 kV / 2 IEC 60 664-1
output to auxiliary circuit: 4 kV / 2 IEC 60 664-1
output to output: 4 kV / 2 IEC 60 664-1
auxiliary circuit to measuring input: 4 kV / 2 IEC 60 664-1

Programming terminals

M-X1-X2-X3: without galv. separation to measuring circuit

EMV

Electrostatic discharge (ESD): 8 kV (air) IEC/EN 61 000-4-2
Fast transients: 2 kV IEC/EN 61 000-4-4
Surge voltage between wires for power supply: 1 kV IEC/EN 61 000-4-5
between wire and ground: 2 kV IEC/EN 61 000-4-5
HF-wire guided: 10 V IEC/EN 61 000-4-6
Interference suppression: Limit value class B EN 55 011

Technical Data

Degree of protection:

Housing: IP 40 IEC/EN 60 529
 Terminals: IP 20 IEC/EN 60 529

Housing: thermoplastic with V0 behaviour according to UL subject 94

Vibration resistance: Amplitude 0.35 mm
 Frequency 10 ... 55 Hz IEC/EN 60 068-2-6
 20 / 060 / 04 IEC/EN 60 068-1

Climate resistance:

Terminal designation: EN 50 005

Wire connection: 1 x 4 mm² solid or
 2 x 1.5 mm² solid or
 1 x 2.5 mm² stranded wire with sleeve
 DIN 46 228-1/-2/-3/-4 or
 2 x 1.5 mm² stranded wire with sleeve
 DIN 46 228-1/-2/-3/

Wire fixing: Plus-minus terminal screws
 M3.5 box terminals with wire protection
 DIN rail IEC/EN 60 715

Mounting:

Weight:
 MK 9837N/5_0: approx. 210 g
 MH 9837/5_0: approx. 295 g
 MH 9837/508: approx. 350 g

Dimensions

Width x height x depth:

MK 9837N/5_0: 22.5 x 90 x 97 mm
 MH 9837/5_0: 45 x 90 x 97 mm

CCC-Data

Auxiliary voltage U_H :

MK9837N/5_0: AC 115, 230 V
 DC 12, 24, 48 V

Switching capacity

to AC 15
 NO contact: 1,5 A / AC 230 V IEC/EN 60 947-5-1



Technical data that is not stated in the CCC-Data, can be found in the technical data section.

Standard Type

MK 9837N.38/500 2 x 5 ... 600 Hz U_H AC 230 V

Article number: 0061295

• 2 adjustable response values at 4 ranges each:

- 5 ... 20 Hz, 15 ... 60 Hz, 50 ... 200 Hz, 150 ... 600 Hz
- Switchable monitoring mode: „2 Level“ or „Window“
- Hysteresis: programmable via terminal: 2 ... 10 %
- start up time delay: settable with external resistor 0 ... 50 s
- Alarm storing or auto-reset selectable
- Frequency input AC 15...280 V / AC 30...550 V
- Closed circuit operation
- Auxiliary voltage U_H : AC 230 V
- Output: 2 changeover contacts
- Width: 22,5 mm

Variants

- MK 9837N.38/550: as MK 9837N.38/500, but with but with measuring input for inverters
- MH 9837.38/5_0: as MK 9837N.38/5_0, but for variants with wide auxiliary voltage range
 Width: 45 mm
- MH 9837.38/508: as MK 9837N.38/500, but with galvanic separated analogue output (current/voltage) and 11 step LED chain.
 Width: 45 mm
- MH 9837.39/5_0: as MK 9837N.38/5_0, jedoch mit 2 x 2 Wechslern
 Width: 45 mm

Ordering example for variants

MK 9837N .38 /5_0 2 x 5 ... 600 Hz U_H AC 230 V

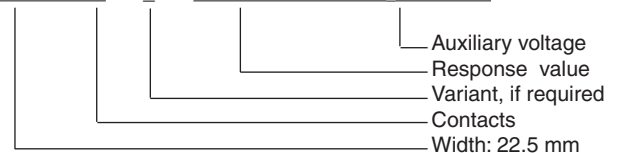

MH 9837 .38 /5_0 2 x 5 ... 600 Hz U_H AC/DC 110 ... 230 V

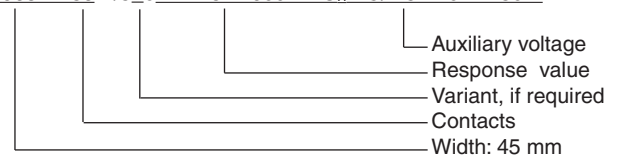

Characteristics

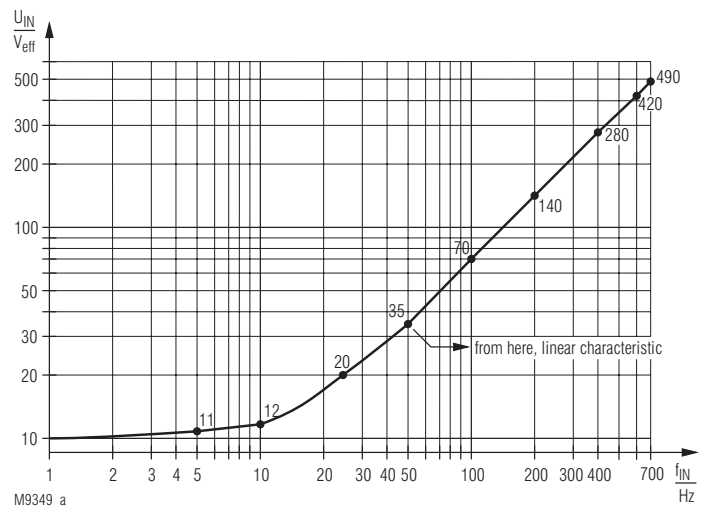

Typical sensitivity of the measuring input at variant
 MK 9837N.12/_5_

