

Your Advantages

- Without sensor and safe
- Fast reaction time
- Easy to retrofit
- Combined with Interlock SAFEMASTER STS

Features

- **According to**
 - Performance Level (PL) e und category 4 to EN ISO 13849-1: 2008
 - SIL-Claimed Level (SIL CL) 3 to IEC/EN 62061
 - Safety Integrity Level (SIL) 3 to IEC/EN 61508 and IEC/EN 61511
- Safe standstill detection on 3- and single-phase motors
- No external sensors necessary
- Independent of direction
- Broken wire detection
- Forcibly guided safety contacts: 3 NO contacts, 1 NC contact for AC 250 V
- 2 semiconductor monitoring outputs
- 1 monitoring output (NO contact)
- Adjustable voltage setting
- Adjustable standstill time delay
- LED indicators for standstill, event of line breakage and operation voltage
- Suitable for operation with inverters
- Width 45 mm

Function Diagramm

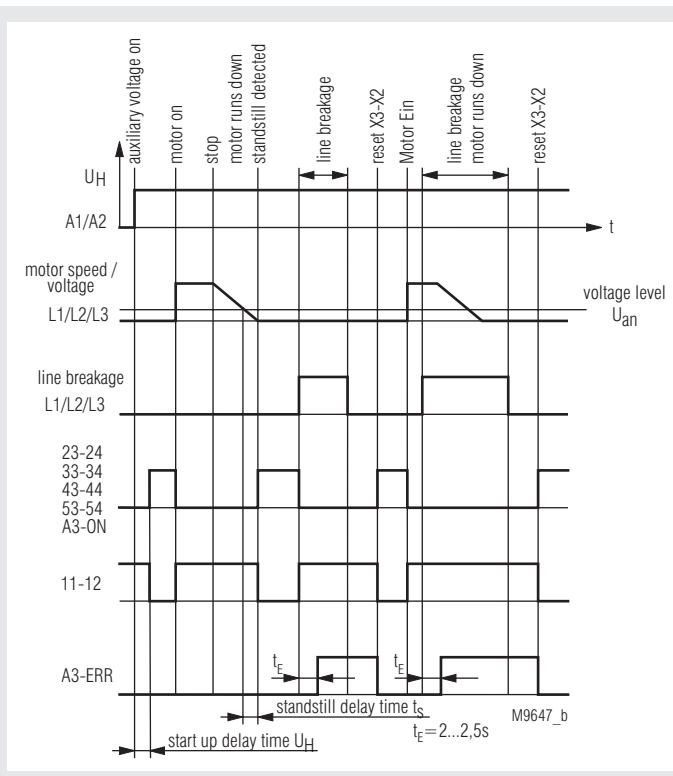

Approval and Markings



Applications

Safe standstill detection on 3- and single-phase motors, e.g. to enable gate interlocks on machine tools or to activate hold in brakes.

Function

The Standstill monitor LH5946 is suitable to monitor the standstill of all electric motors that generate a remanence voltage while coasting to stop. The LH 5946 is connected to the motor terminals and measures the induced back emf voltage. 2 redundant measuring channels are used (L2-L1 and L3 L1). If the back emf voltage drops to 0 simultaneously in both channels this indicates standstill and the output relay is energized.

To adopt the unit to all different types of motors and applications the voltage threshold indicating standstill on LH 5946 is adjustable. Also the time delay between detection and energisation of the relay is adjustable (standstill time t_s).

In addition the unit detects broken wire on the measuring inputs L1 / L2 / L3. If broken wire is detected the output relays goes into safe state (as with running motor). This state is stored and can be reset by bridging terminals X3-X2.

The input signals of both channels are permanently compared. If the signals are different for more then 2.5 sec a simultaneity failure is detected. This failure resets when both input channels receive simultaneous signals with a level, above the voltage threshold and hysteresis.

To the terminals X1-X2 the feedback circuit of external contactors (used for contact reinforcement) is connected (NC contact). If no feedback circuit is required, these terminals must be linked. Open terminals will cause a failure message.

Notes

The terminals X1 - X2 - X3 has no galvanic separation to the measuring circuit L1 - L2 - L3. They must be controlled with volt free contacts.

Flashing Codes

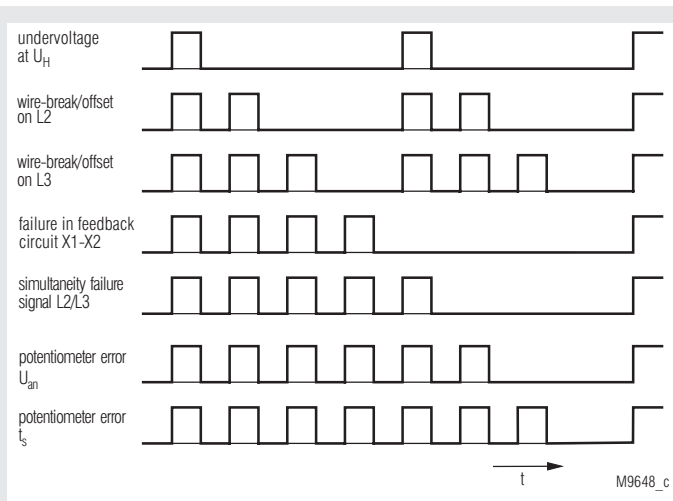

Flashing codes of the LED „ERR“ in sequence of priority

Circuit Diagram

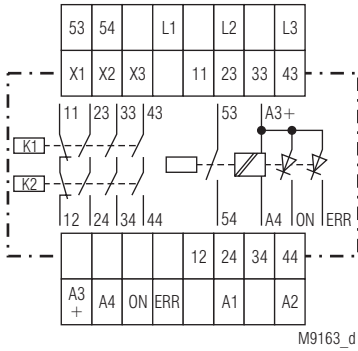

Connection terminals

| Terminal designation | Signal designation |
|---------------------------|--|
| L1 - L2 - L3 | Connection to monitored motor |
| 11 - 12 | Safety contacts (NC) |
| 23 - 24, 33 - 34, 43 - 44 | Safety contacts (NO) |
| 53 - 54 | Monitoring contact (NO) |
| X1 - X2 | Connection of feedback circuit (for external contactors) |
| X2 - X3 | Manual reset for external faults |
| A1 - A2 | Auxiliary supply (U_H) |
| A3(+) - A4 | Supply for semiconductor outputs |
| ON: | Semiconductor output indicates state of safety contacts |
| ERR: | Semiconductor output indicates failures |

Attention: The outputs 53-54, ON and ERR are only monitoring outputs and must not be used in safety circuits!

Indicators

| | |
|-------------------------|---|
| green-red LED „UH“: | green on, when operation red on, with internal error |
| yellow-green LED „OUT“: | yellow on, at $EMK > U_{an}$ flashes green at time progression of t_s permanent on, when output contacts are enable |
| red LED „ERR“: | flashes at error in measuring and feedback circuit and low auxiliary voltage U_H (see flashing codes) |

Technical Data

Input (L1 - L2 - L3)

| | |
|--|--|
| Measuring-/Motor voltage: | max. AC 690 V |
| Input resistance: | 500 k Ω |
| Response value U_{an}: | 20 mV ... 400 mV, adjustable or 0.2 ... 4 V, adjustable |

Response value dependent on frequency

| | | | | | | | | |
|--------------------------------------|-----|-----|-----|-----|-----|-----|-------|----|
| Input frequency (Hz): | 50 | 100 | 200 | 400 | 600 | 1k | 1,5 k | 2k |
| Multiplication factor for U_{an} : | 1,0 | 1,1 | 1,2 | 1,5 | 2,0 | 2,8 | 5 | 8 |

Hysteresis (for detection of running motor):

100 %

Release delay for detection of running motor:

< 100 ms

Standstill time delay t_s :

0.2 ... 6 s adjustable

Auxiliary voltage U_H (A1 - A2):

AC 115 V, AC 230 V, AC 400 V, DC 24 V

Recommended fusing:

2 A

Voltage range

| | |
|-----------------------------|-----------------------|
| AC: | 0.8 ... 1.1 U_N |
| DC: | 0.9 ... 1.2 U_N |
| Nominal consumption: | 5 VA, $\frac{1}{3}$ W |

Nominal frequency (AC):

50 / 60 Hz

Frequency range (AC):

45 ... 65 Hz

max. residual ripple (DC):

10 %

Start up delay when connecting U_H at standstill:

0,4 ... 0,8 s + adjustable t_s

Output

Contacts

(safety contacts)

LH 5946.48:

3 NO contacts, 1 NC contact
relay, positive guide

Contact type:

AC 250 V

Nominal output voltage:

Thermal current I_{th} :

5 A (bis 40°C)

Quadratic total current:

see derating curve

Switching capacity

to AC 15

NO contact:

3 A / AC 230 V

IEC/EN 60 947-5-1

NC contact

2 A / AC 230 V

IEC/EN 60 947-5-1

to DC 13

NO contact:

1 A / DC 24 V

IEC/EN 60 947-5-1

NC contact

1 A / DC 24 V

IEC/EN 60 947-5-1

to DC 13

NO contact:

4 A / 24 V at 0.1 Hz IEC/EN 60 947-5-1

NC contact

4 A / 24 V at 0.1 Hz IEC/EN 60 947-5-1

Fusing of the safety contacts:

max. fuse rating 4AgL
line circuit breaker C6A
1200 / h

Max. operating frequency:

Contact service life

at AC 230 V / 5 A $\cos\varphi = 0.5$:

$\geq 2 \times 10^5$ switching cycles

Mechanical life:

$\geq 50 \times 10^6$ switching cycles

Semiconductor monitoring output:

100 mA DC 24 V, plus switching,
galvanic separation; supply via
A3+ / A4 for output; „ON“ and „ERR“

NO monitoring contact:

3 A AC 250 V (closed when enabled)

Technical Data

General Data

| | |
|--|---|
| Nominal operating mode: | continuous operation |
| Temperature range operation: | - 25 ... + 60°C (+ 40°C with max. contact current, see Derating) |
| storage: | - 40 ... + 75°C |
| Altitude: | < 2.000 m |
| Clearance and creepage distance | |
| rated impulse voltage / pollution degree: | IEC 60 664-1 |
| Contacts 11/12, 23/24, 33/34, 43/44 against all others: | 6 kV / 2 |
| Contacts 11/12, 23/24, 33/34, 43/44 against each others: | 4 kV / 2 |
| Indicator contact 53/54 against all others: | 4 kV / 2 |
| Semiconductor outputs A3+/ ON / ERR / A4 against all others: | 6 kV / 2 |
| Auxiliary voltage A1 / A2 against all others | |
| at auxiliary voltage AC: | 6 kV / 2 |
| at auxiliary voltage DC: | 4 kV / 2 |
| Control terminal X1 / X2 / X3: | no galvanic separation to L1 / L2 / L3 |
| EMC | IEC/EN 62 061 |
| Interference suppression: | limit value class B EN 55 011 |
| Degree of protection | |
| Housing: | IP 40 IEC/EN 60 529 |
| Terminals: | IP 20 IEC/EN 60 529 |
| Enclosure: | thermoplastic with VO behaviour according to UL subject 94 |
| Vibration resistance: | amplitude 0.35 mm frequency 10 ... 55 Hz, IEC/EN 60 068-2-6 25 / 060 / 04 IEC/EN 60 068-1 |
| Climate resistance: | |
| Terminal designation: | EN 50 005 |
| Wire connection | DIN 46 228-1/-2/-3/-4 |
| UL detail: | 60°C Copper conductors only |
| Screw terminals (integrated): | 1 x 4 mm ² solid or 1 x 2.5 mm ² stranded ferruled or 2 x 1.5 mm ² stranded ferruled or 2 x 2.5 mm ² solid |
| Insulation of wires or sleeve length: | 8 mm |
| Plugin with screw terminals max. cross section for connection: | 1 x 2.5 mm ² solid or 1 x 2.5 mm ² stranded ferruled |
| Insulation of wires or sleeve length: | 8 mm |
| Plugin with cage clamp terminals max. cross section for connection: | 1 x 4 mm ² solid or 1 x 2.5 mm ² stranded ferruled |
| min. cross section for connection: | 0.5 mm ² |
| Insulation of wires or sleeve length: | 12 ±0.5 mm |
| Wire fixing: | Plus-minus terminal screws M 3.5 box terminals with wire protection or cage clamp terminals |
| Mounting: | DIN-rail IEC/EN 60 715 |
| Weight: | approx. 400 g |

Dimensions

Width x height x depth: 45 x 90 x 121 mm

Technical Data

Safety Related Data

Values according to EN ISO 13849-1:

| | | |
|-----------------------|----------|-----------------|
| Category: | 4 | |
| PL: | e | |
| MTTF _d : | 93 | a |
| DC _{avg} : | 99.0 | % |
| d _{op} : | 365 | d/a (days/year) |
| h _{op} : | 24 | h/d (hours/day) |
| t _{Zyklus} : | 28.8E+03 | s/Zyklus |
| | ≈ 1 | /8 h (hours) |

Values according to IEC/EN 62061 / IEC/EN 61508 / IEC/EN 61511:

| | | |
|----------------------|----------|--------------------------------|
| SIL CL: | 3 | IEC/EN 62061 |
| SIL | 3 | IEC/EN 61508 / IEC/EN 61511 |
| HFT ¹⁾ : | 1 | |
| DC _{avg} : | 99.0 | % |
| SFF _{avg} : | 99.7 | % |
| PFH _D : | 4.10E-10 | h ⁻¹ |
| PFD: | 1,42E-04 | |
| T _i : | 20 | a (year) |

¹⁾ HFT = Hardware-Failure Tolerance



The values stated above are valid for the standard type.

Safety data for other variants are available on request.

The safety relevant data of the complete system has to be determined by the manufacturer of the system.

UL-Data

The safety functions were not evaluated by UL. Listing is accomplished according to requirements of Standard UL 508, "general use applications"

Auxiliary voltage U_H

for DC 24 V: Device must be supplied with a Class 2 or a voltage / current limited power supply (max. 4 A).

Measuring-/Motor voltage: max. AC 600 V

Ambient temperature: - 25 ... + 60°C, (+ 40°C with max. contact current, see Derating)

Switching capacity

safety contacts
(11/12, 23/24, 33/34, 43/44)
Ambient temperature 40°C:

Pilot duty B300
5A 250Vac G.P.
5A 24Vdc G.P.

Ambient temperature 60°C:

Pilot duty B300
2A 250Vac G.P.
2A 24Vdc G.P.

Switching capacity

indicator contact (53/54)

3A 250Vac G.P.

Wire connection:

Fixed screw terminal:

60°C / 75°C copper conductors only
1 x AWG 20 - 12 Sol/Str Torque 0.8 Nm or
2 x AWG 20 - 14 Sol/Str Torque 0.8 Nm

Plugin screw terminal:

AWG 20 - 14 Sol Torque 0.8 Nm or
AWG 20 - 18 Str Torque 0.8 Nm

Plugin cage clamp terminal:

AWG 20 - 12 Sol/Str



Technical data that is not stated in the UL-Data, can be found in the technical data section.

EAC-Data

Auxiliary voltage U_H: DC 24V



Technical data that is not stated in the UL-Data, can be found in the technical data section.

Standard Type

- LH 5946.48/61 20 ... 400 mV UH DC 24 V 0.2 ... 6 s
 Article number: 0059266
- Safety output: 3 NO contacts, 1 NC contact
 - Response value U_{an} : 20 ... 400 mV
 - Auxiliary voltage U_H : DC 24 V
 - Standstill time t_s : 0.2 ... 6 s
 - 1 semiconductor and 1 NO contact for indicator output
 - 1 semiconductor for fault indicator output
 - Width: 45 mm

Ordering Example

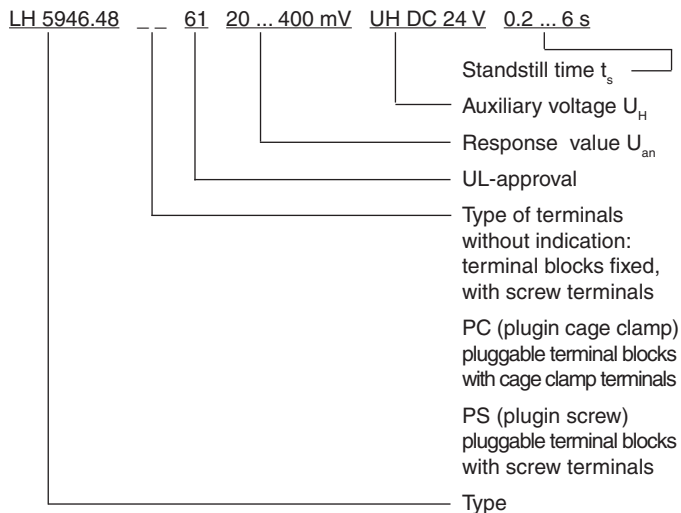

Options with Pluggable Terminal Blocks

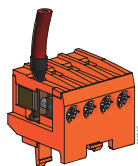

Screw terminal
(PS/plugin screw)

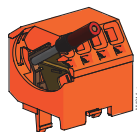

Cage clamp terminal
(PC/plugin cage clamp)

Notes

Removing the plugin terminal blocks

1. The unit has to be disconnected.
2. Insert a screwdriver in the side recess of the front plate.
3. Turn the screwdriver to the right and left.
4. Please note that the terminal blocks have to be mounted on the belonging plug in terminations.

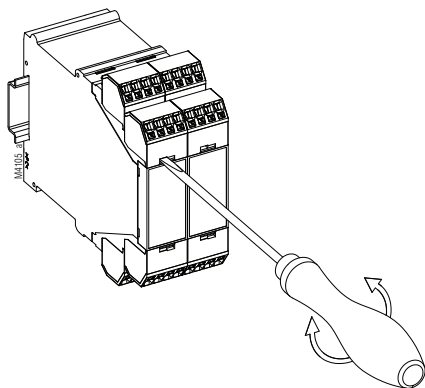

Characteristic

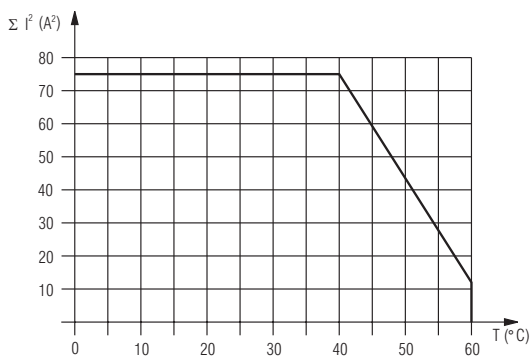

Quadratic total current

$$\Sigma = I_1^2 + I_2^2 + I_3^2$$

I_1, I_2, I_3 - current in contact paths

max. permitted current up to 40°C on 3 contact paths = 5A

$$(5^2 + 5^2 + 5^2 = 75A^2)$$

max. permitted current up to 60°C on 3 contact paths = 2A

$$(2^2 + 2^2 + 2^2 = 12A^2)$$

Derating curve for contact currents of safety contacts

Application Examples

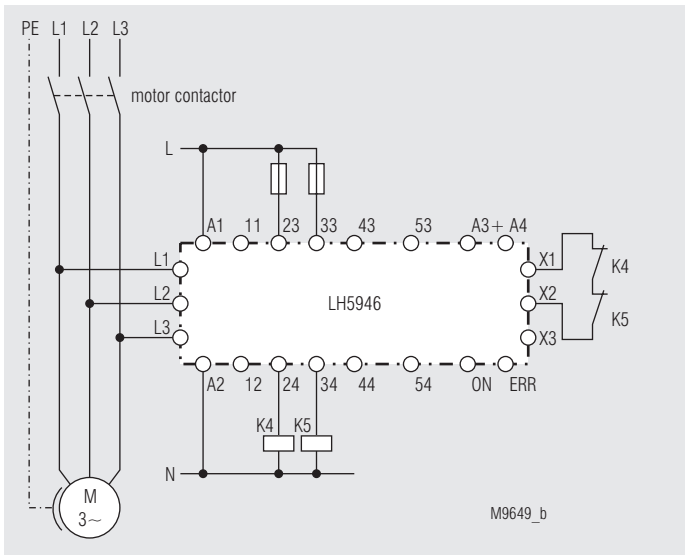

With 3-phase motor; suitable up to SIL3, Performance Level e, Cat. 4

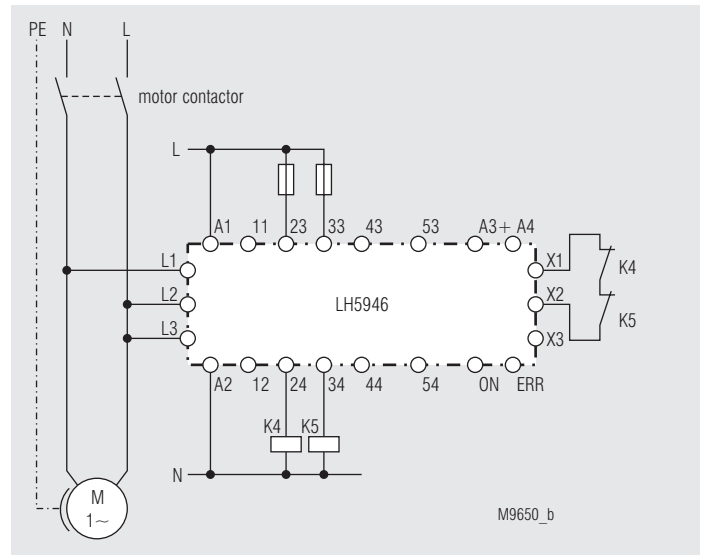

With single-phase motor; suitable up to SIL3, Performance Level e, Cat. 4

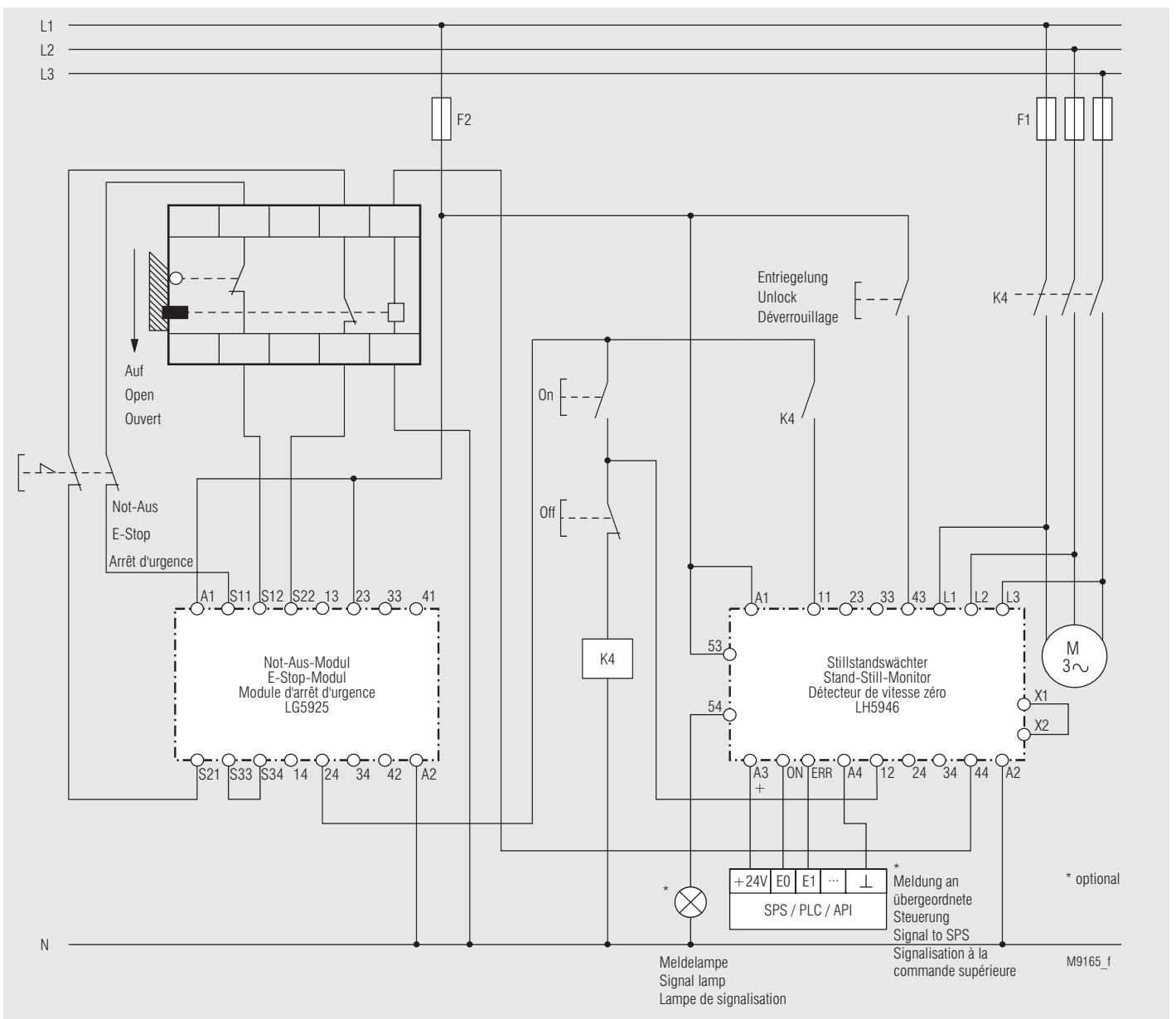

Typical connection combination with E-Stop; suitable up to SIL3, Performance Level e, Cat. 4

Application Examples

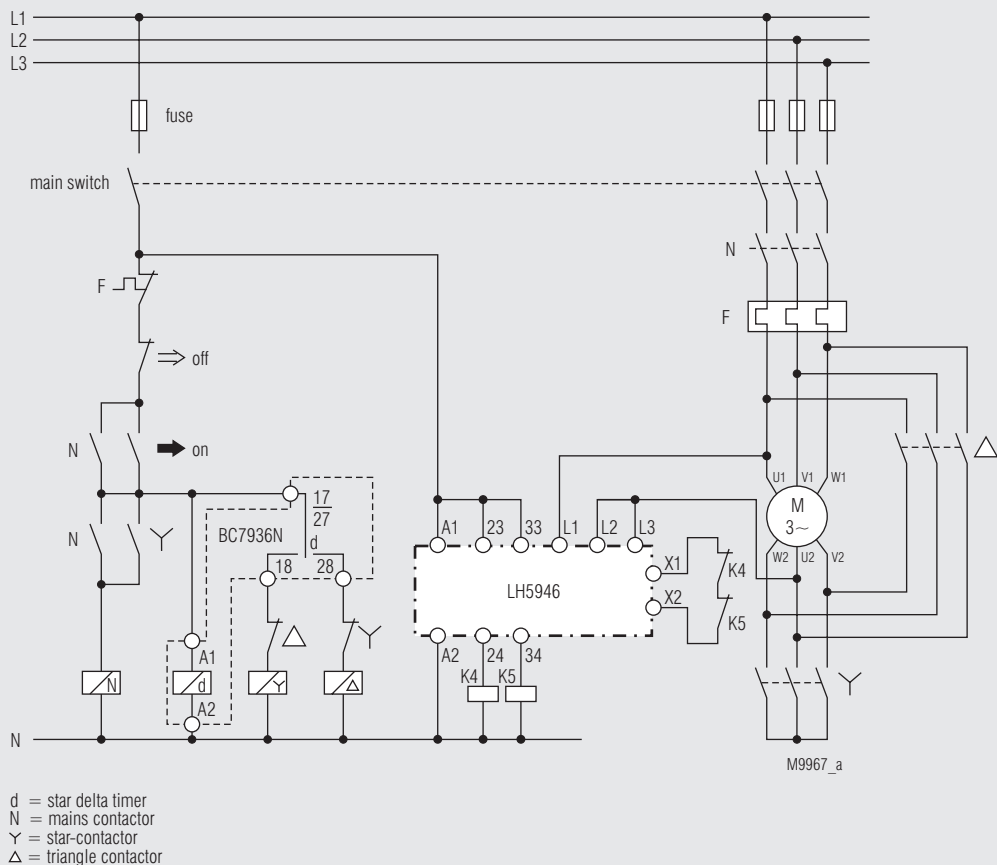

Typical connection combination with star delta timer, 2-channel connection of the measuring inputs; suitable up to SIL3, Performance Level e, Cat. 4

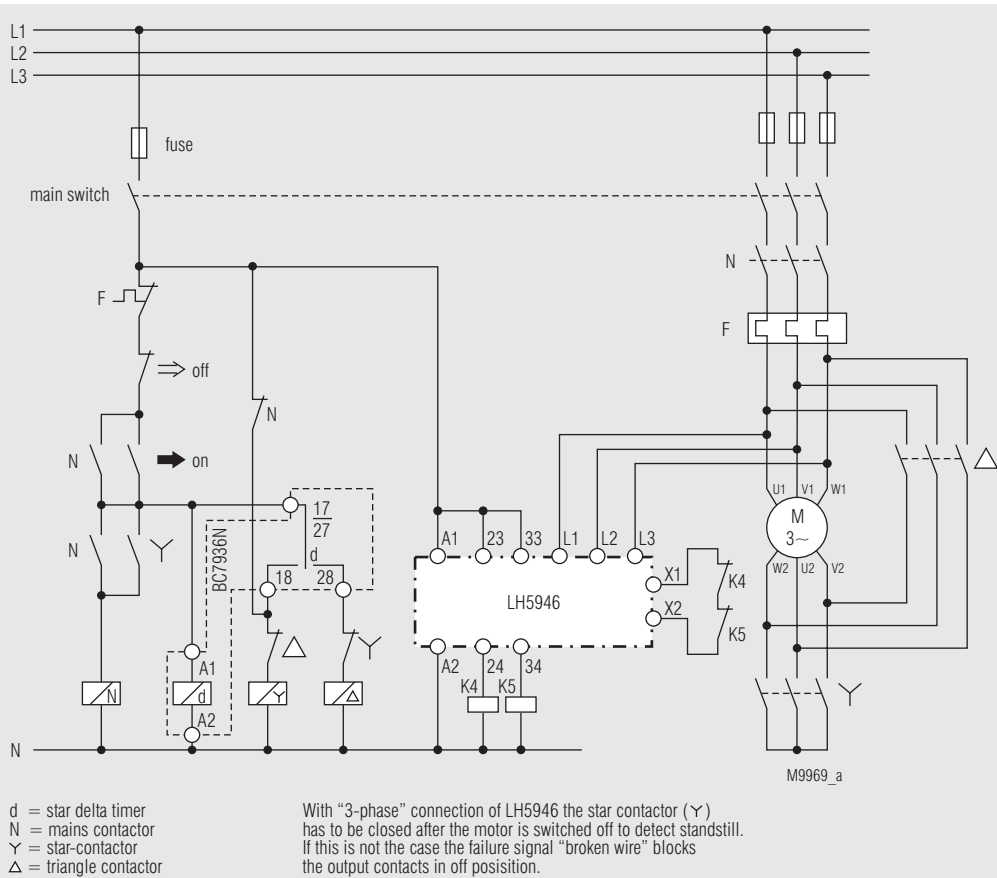

Typical connection combination with star delta timer, 3-channel connection of the measuring inputs; suitable up to SIL3, Performance Level e, Cat. 4