

MINIMASTER Analogue Module for CANopen IL 5508



- According to IEC/EN 61 131-2
- CANopen interface according to DS301 version 3.0, DS401
- 2 analogue inputs with each 2 x 0 ... 10 V, 2 x 0 ... 20 mA or 2 x Pt 100 (- 50 ... 300°C)
- Galvanic separation between inputs, bus and auxiliary supply
- LED indicators for supply voltage and Bus status
- 35 mm width

Approvals and Markings



Circuit Diagrams

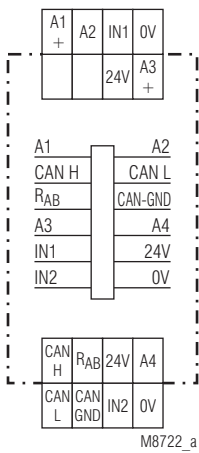

IL 5508.90/100
IL 5508.90/110

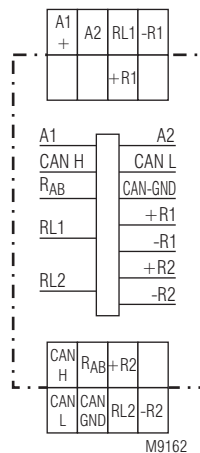

IL 5508.90/122

Application

The analog input module IL 5508 collects signals of a control circuit from limit switches, push buttons, sensors etc. The module is used in industrial control circuits and building automation.

Indicators

- yellow LED "Power": on, when supply connected
- yellow LED "BUS": on, when bus is active, pulsing when bus is inactive

Setting and Adjustment

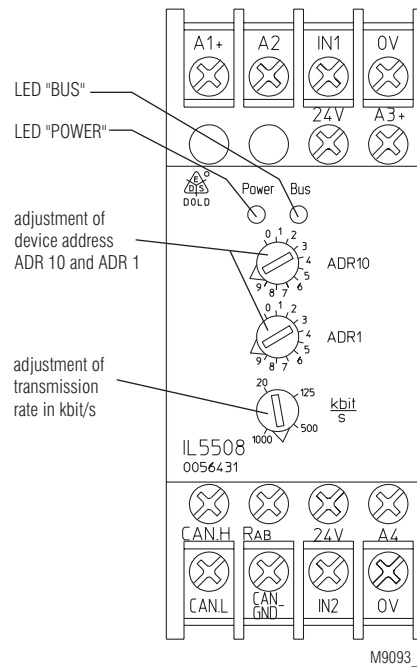

The configuration is made with the programming software PN 5501 in conjunction with minimaster IL 5504 / IN 5504 or e.g. with ProCANopen. The corresponding configuration file on CD can be ordered under order no. PN 5501, article no. 0052860

Set-up Procedure

1. Connect device to CANopen-bus
2. The CANopen bus cable has to be terminated with a 120 Ω resistor on both ends (on DOLD devices this can be done by linking the terminals CAN-H and R_{AB})
3. Adjust transmission speed (e. g. 20 k bit / s)
4. Adjust device addresses
5. Configure bus, e.g. with ProCANopen

Technical Data

Auxiliary voltage

Auxiliary voltage U_H A1/A2: DC 24 V
Voltage range: 0.85 ... 1.2 U_N
Nominal consumption: < 2 W at DC 24 V

Sensor supply

Variant / __ 0: Sensor supply via terminal A3 (+) and A4, DC 24 V
Variant / __ 1: Sensor supply internally from A1 (+) and A2 via galvanic separated DC/DC-converter, max. 24 V / 35 mA-channel

Input

Inputs 2, single endet galvanic separated to bus and auxiliary supply

Galvanic separation:

Input voltage: AC 350 V_{eff}
Input current: 0 ... 10 V
Input current: 0 ... 20 mA

Thermal resistance

Pt 100: - 50 ... 300°C

Input impedance: > 100 kΩ for 0 ... 10 V
 82 Ω for 0 ... 20 mA

Measuring current

Pt 100: 1.13 mA

Connection: 2-wire screened for 0 ... 10 V / 0 ... 20 mA
 3-wire screened for Pt 100

Common mode voltage: 50 V max.

Resolution: 12 bit

Converting: successive approximation

Measuring error: < ± 0.25 % of end of scale value
 for 0 ... 10 V; 0 ... 20 mA

Pt 100: < ± 1 % of end of scale value

Quantisation: 2.5 mV

5 µA

0.1°C

Measuring principle: integrating (mean value)

CANopen interface

IL 5508.90/1 __: galvanic separation according to ISO 11 898-1

Wire: screened twisted pair

Transmission speed: adjustable 20 k bit/s, 125 k bit/s, 500 k bit/s, 1 M bit/s,

max. Bus length: 20 k bit/s = 2.500 m

125 k bit/s = 500 m

500 k bit/s = 90 m

1 M bit/s = 15 m

General Data

Operating mode: Continuous operation

Temperature range: - 20 ... + 60°C

EMC

Electrostatic discharge: 8 kV (air) IEC/EN 61 131-2

HF-irradiation: 10 V IEC/EN 61 000-4-6

Fast transients wires for power supply: 2 kV IEC/EN 61 131-2

Fast transients analogue input: 0.25 kV IEC/EN 61 131-2

Interference suppression: Limit value class B EN 55 011

Degree of protection

Housing: IP 40 IEC/EN 60 529

Terminals: IP 20 IEC/EN 60 529

Housing: Thermoplastic with V0-behaviour according to UL subject 94

Mech. operating conditions: EN 61 131-2

Climate resistance: EN 61 131-2

Terminal designation: EN 50 005

Wire connection: 2 x 2.5 mm² solid or 2 x 1.5 mm² stranded wire with sleeve

DIN 46 228-1/-2/-3/-4

Wire fixing: Flat terminals with self-lifting

clamping peace IEC/EN 60 999-1

Mounting: DIN rail IEC/EN 60 715

Weight: 110 g

Dimensions

Width x height x depth: 30 x 90 x 61 mm

Standard Types

IL 5508.90/100 DC 24 V

Article number: 0056431
 • 2 analogue inputs 0 ... 10 V
 • Nominal voltage U_N : DC 24 V
 • Sensor supply: on terminal A3 / A4

IL 5508.90/110 DC 24 V

Article number: 0056807
 • 2 analogue inputs 0 ... 20 mA
 • Nominal voltage U_N : DC 24 V
 • Sensor supply: on terminal A3 / A4

IL 5508.90/122 DC 24 V

Article number: 0056957
 • 2 analogue inputs Pt 100 - 50 ... 300°C
 • Nominal voltage U_N : DC 24 V
 • Sensor supply: constant current source 1.13 mA

Ordering Example

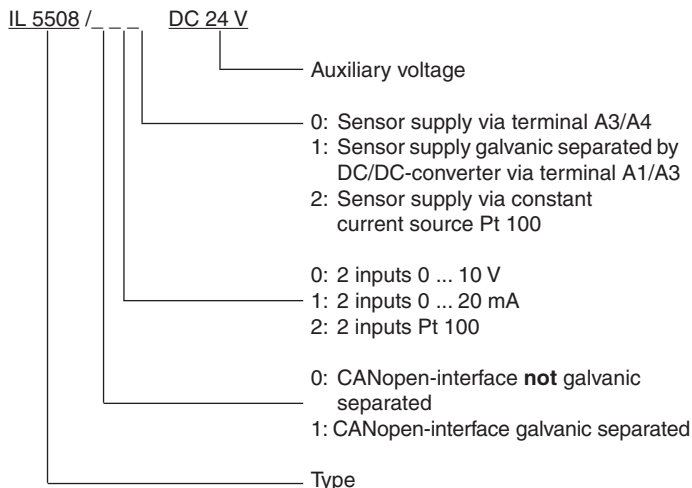

Accessories

- CANopen PLC IL 5504
- Input / Output Module IN 5509
- Input Module, Digital IP 5502
- Output Module, Digital IP 5503
- Input Module, Analogue IL 5508
- Output Module, Analogue IL 5507

Application Examples

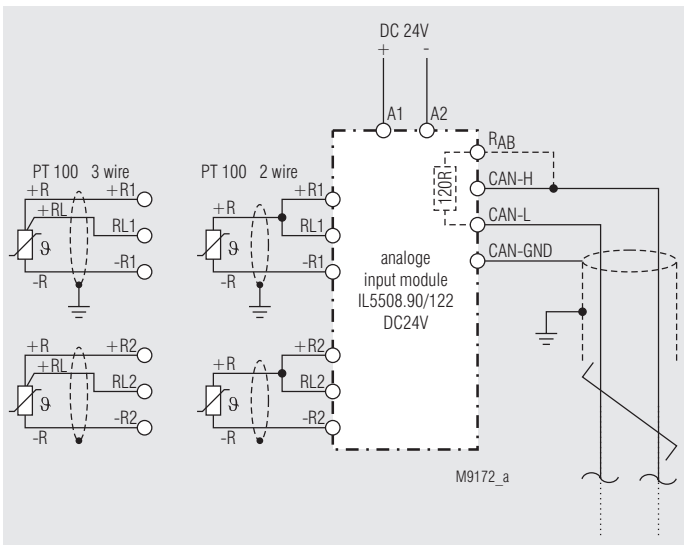
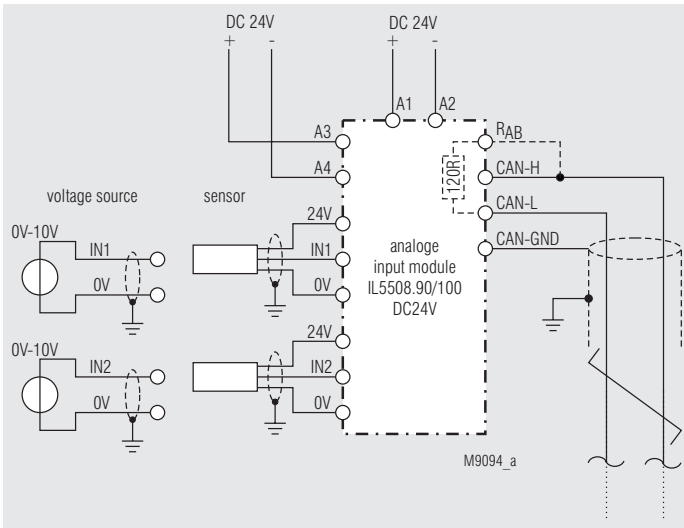

CAN-signals

CAN-H:	CAN_H bus line (dominant high)
CAN-L:	CAN_L bus line (dominant high)
R _{AB} :	Termination resistor 120 Ω
CAN-GND:	reference potential of CAN-transceiver

Notes for wiring

- Mixed networks, or networks that are not galvanically separated
 - CAN-GND is connected between all devices (CIA DRP 303-1).
 - if no 3rd wire is available in the bus cable, the screen of the cable can be used. In this case the screen has to be connected to PE at one point.
- Galvanic separated networks
 - if the networks are completely separated CAN-GND must not be wired (CIA DRP 303-1).
 - The screen is connected to PE.
- An equalisation of potentials between units in far distance has to be provided.
- The CAN-bus must be terminated at the first and last device on the bus with a 120 Ω resistor, e.g. insert a link on terminals R_{AB} and CAN-H.
- Analogue signal wires must be screened. the screen has to be connected to ground near to the input module.
- To achieve proper function, the DIN rail must have a good connection to ground.

Application Example

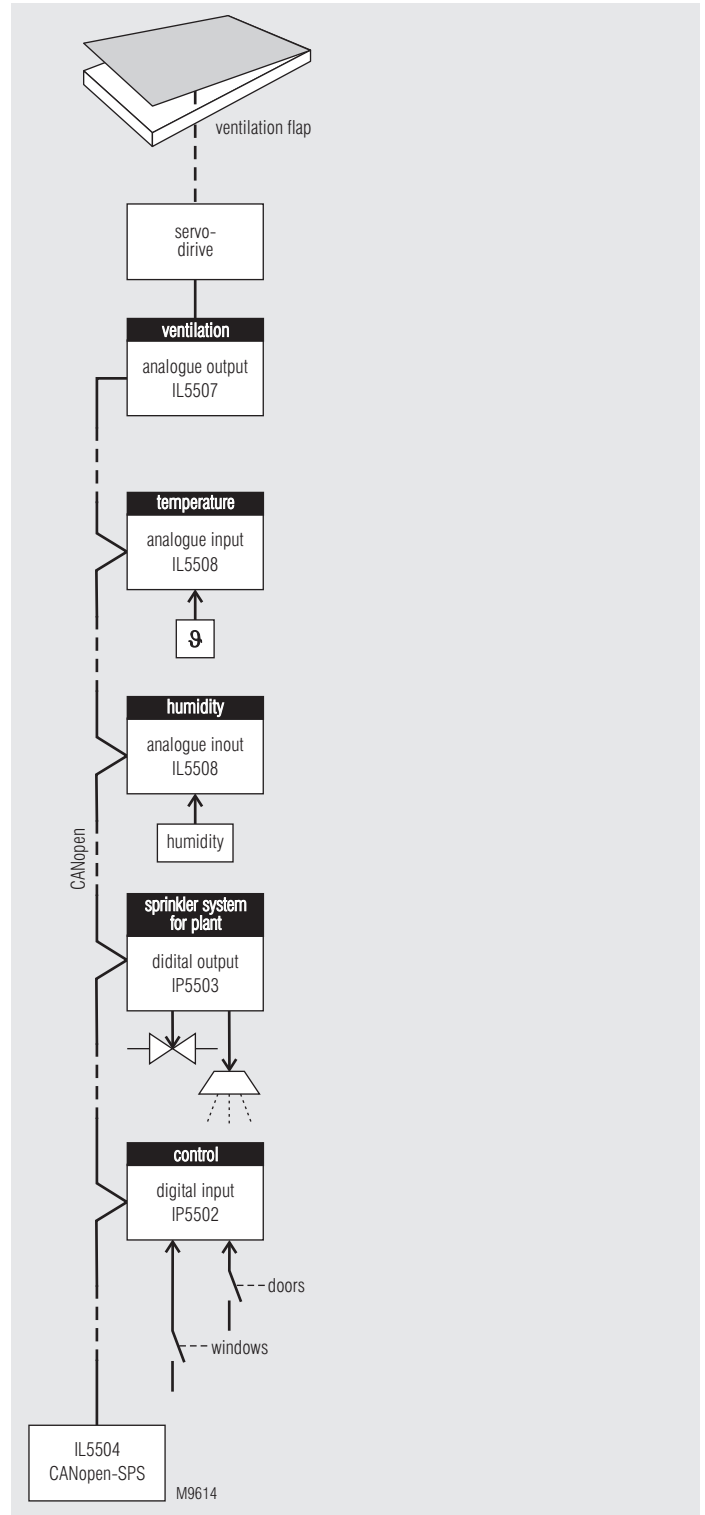

CANopen-application for greenhouses: dependend on temperature- and humidity ventilation flap applications and sprinkler systems for plants in a greenhouse.

